

How to use saws

Types of saw

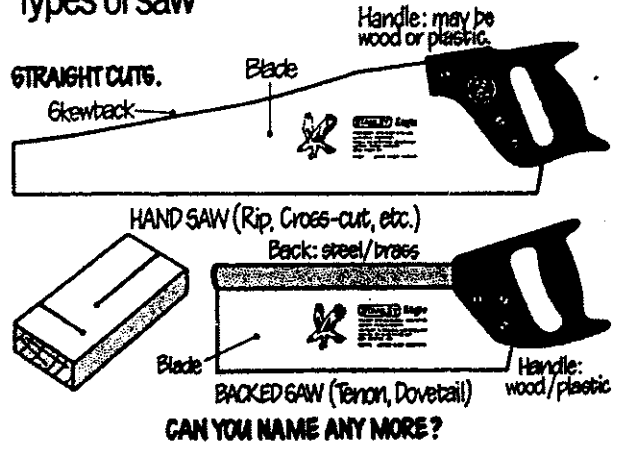

CURVED CUTS: TENSIONED SAWS.

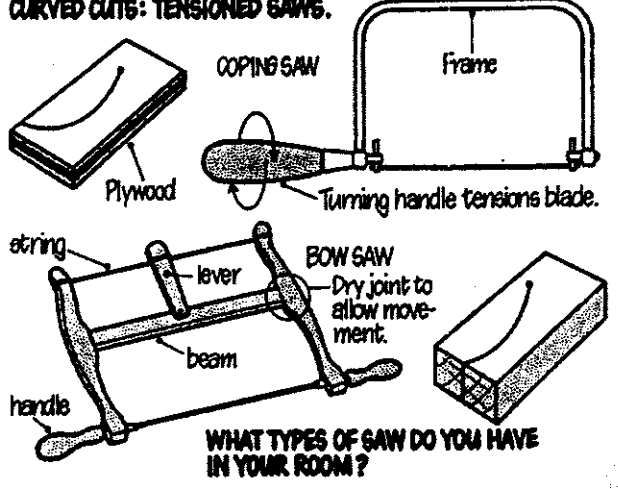

Teeth patterns

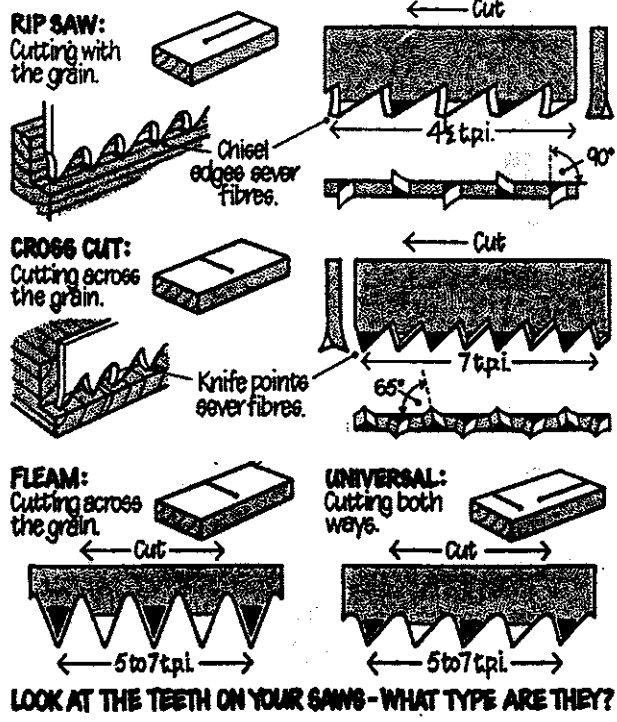

Which side of the line?



Back Saws - for general bench work e.g. Tenon Saw

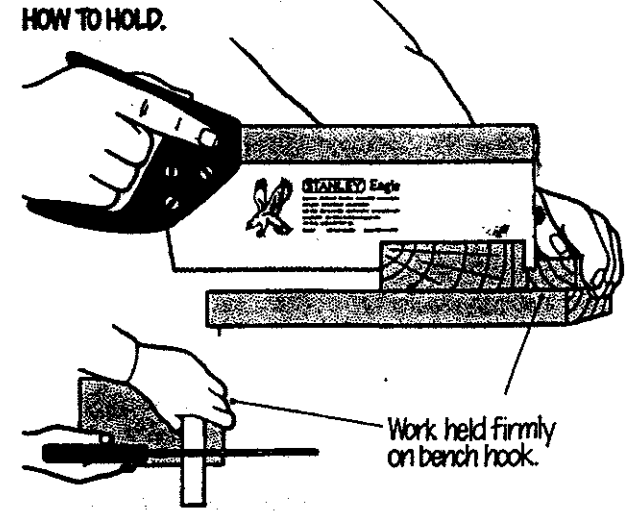

Coping Saw - curved shapes in fairly thin wood e.g. plywood

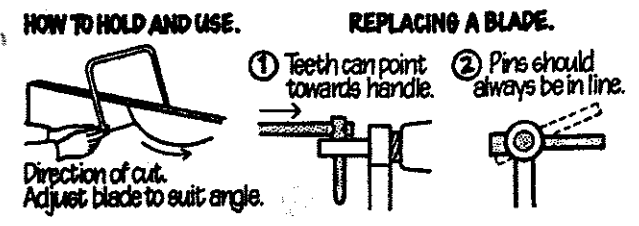

How a saw works

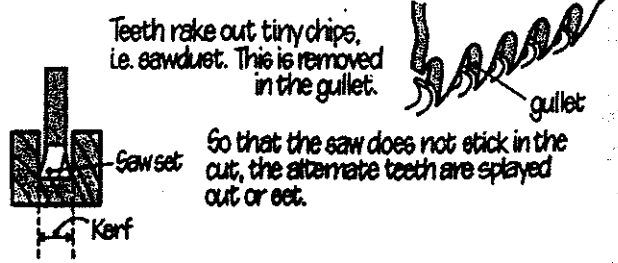

Hand Saws - long deep cuts

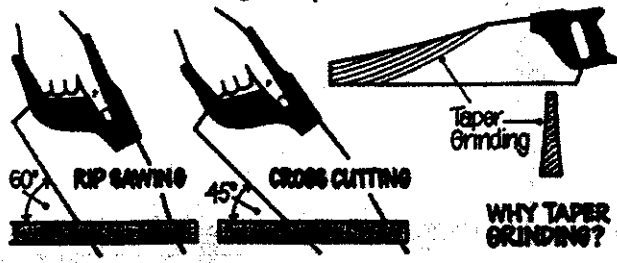

Bow Saw - curved shapes in thicker wood

